

CHAPTER 12
ACCESSIBLE PEDESTRIAN DESIGN

CHAPTER 12 12-1

ACCESSIBLE PEDESTRIAN DESIGN 12-1

12.0 INTRODUCTION 12-5

12.1 ADA ACCESSIBILITY REQUIREMENTS, STANDARDS & GUIDELINES..... 12-6

New Construction Project Requirements..... 12-6

Alteration Project Requirements..... 12-6

Non-Alteration Project Requirements..... 12-8

Technically Infeasible..... 12-9

Unaltered Existing Facilities & Transition Plan 12-9

12.2 TECHNICAL REQUIREMENTS FOR ACCESSIBILITY..... 12-9

Pedestrian Access Route Technical Requirements 12-10

12.3 CURB RAMP GENERAL INFORMATION..... 12-15

12.4 CURB RAMP TYPES 12-16

12.4 CURB RAMP TECHNICAL REQUIREMENTS 12-18

12.5 DETECTABLE WARNING SURFACES 12-23

12.6 PEDESTRIAN CROSSING CONTROLS 12-26

12.7 PEDESTRIAN RAMPS & LANDINGS 12-28

List of Figures

Figure 12-1 - Passing Spaces 12-10

Figure 12-2 - Pinch Points 12-11

Figure 12-3 - Allowable Vertical Discontinuities..... 12-12

Figure 12-4 - Horizontal Openings in Grates 12-12

Figure 12-5 - Protruding Objects 12-13

Figure 12-6 - Protection from Stairways 12-13

Figure 12-7 - Pedestrian Street Crossing Cross Slope 12-14

Figure 12-8 - Curb Ramp Elements 12-15

Figure 12-9 - Preferred Curb Ramp Placement 12-16

Figure 12-10 - Perpendicular Curb Ramp Examples 12-17

Figure 12-11 - Parallel Curb Ramp Example 12-17

Figure 12-12 - Blended Transition/Depressed Corner Example..... 12-18

Figure 12-13 - Curb Ramp Grade Breaks 12-19

Figure 12-14 - Curb Ramp Turning Spaces..... 12-20

Figure 15 - Transitioning Steep Roadway Slopes.....	12-20
Figure 12-16 - Perpendicular Curb Ramp Clear Spaces.....	12-21
Figure 12-17 - Flared Sides.....	12-22
Figure 12-18 - Curb Ramp Counter Slope Requirements.....	12-22
Figure 12-19 - Parallel Curb Ramp DWS Placement.....	12-24
Figure 12-20 - Perpendicular Curb Ramp DWS Placement.....	12-25
Figure 12-21 - Pedestrian Refuge DWS Placement.....	12-26
Figure 12-22 - Ped Push Button Reach Ranges.....	12-27
Figure 12-23 - Ped Push Button Placement.....	12-28
Figure 12-24 - Pedestrian Ramp Elements.....	12-29
Figure 12-25 - Pedestrian Ramp Turning Space Requirements.....	12-29

List of Definitions

Accessible - Describes a facility in the public right-of-way that complies with the requirements set forth in the ADAAG or PROWAG.

ADA - An acronym for the Americans with Disabilities Act.

ADA Transition Plan - The 1991 ADA regulation (28 CFR Part 35) required all public entities to evaluate all of their services, policies, and practices and to modify any that did not meet ADA requirements. Public entities with 50 or more employees were required to develop a transition plan detailing any structural changes that would be undertaken to achieve program access and specify a period for their completion.

ADAAG – An acronym for ADA Accessibility Guidelines

Accessible Pedestrian Signal (APS) - A traffic signal that incorporates a device to communicate information to a pedestrian in audible and vibrotactile formats.

Alteration - A change to a facility in the public right-of-way that affects or could affect pedestrian access, circulation, or use. Alterations include, but are not limited to, resurfacing, rehabilitation, reconstruction, historic restoration, or changes or rearrangement of structural parts or elements of a facility.

Blended Transition - A raised pedestrian street crossing, depressed corner, or similar connection between the pedestrian access route at the level of the sidewalk and the pedestrian street crossing. Blended transitions have a grade of five percent or less.

Cross Slope - The grade that is perpendicular to the dominant direction of pedestrian travel.

Curb Ramp - A combination of a ramp and landing to accomplish a change in elevation at a curb face. This element provides street and sidewalk access to pedestrians in wheelchairs or with mobility impairments.

Detectable Warning Surface (DWS) - A standardized surface feature of truncated domes that provides an indication to individuals with disabilities that they are transitioning from the pedestrian realm to the vehicular way.

Equivalent Facilitation - The use of alternative designs, products, or technologies that result in substantially equivalent or greater accessibility and usability than the requirements in the PROWAG and/or ADAAG.

Facility - All or any portion of buildings, structures, improvements, elements, and pedestrian or vehicular routes located in the public right-of-way.

Grade Break - The line where two surface planes with different grades meet.

Landing - The area of the Pedestrian Access Route at the top or bottom of a curb ramp. Also referred to as “Turning Space”.

Maximum Extent Feasible - Where existing physical constraints make it impracticable for altered elements, spaces, or facilities to fully comply with the requirements for new construction, compliance is required to the extent practicable within the scope of the project. Also referred to as “Maximum Extent Practicable”.

Mobility Device – Any assistive technology or device that aids the movement of people with a physical impairment. Examples include lift chairs, wheelchairs, scooters, etc.

Operable Part - A component of an element used to insert or withdraw objects, or to activate, deactivate, or adjust the element.

Other Power-Driven Mobility Device (OPMD) – An OPMD is any mobility device powered by batteries, fuel, or other engines that is used by individuals with mobility disabilities for the purpose of locomotion, whether or not it was designed primarily for use by individuals with mobility disabilities. OPMDs may include electronic personal assistance mobility devices, such as the Segway ® Personal Transporter (PT), or any mobility device that is not a wheelchair and is designed to operate in areas without defined pedestrian routes.

Pedestrian - A person afoot or in a wheelchair or other power-driven mobility device (OPMD).

Pedestrian Access Route (PAR) - A continuous and unobstructed path of travel provided for pedestrians with disabilities within or coinciding with a pedestrian circulation path.

Pedestrian Circulation Path - A prepared exterior or interior surface provided for pedestrian travel in the public right-of-way.

PROWAG - An acronym for the Public Rights-of-Way Accessibility Guidelines.

Qualified Historic Facility - A facility that is listed in or eligible for listing in the National Register of Historic Places, or designated as historic under an appropriate state or local law.

Running Slope - The grade that is parallel to the dominant direction of pedestrian travel.

Sidewalk - A paved pathway paralleling the highway or street that is intended for pedestrian travel.

Shared Use Path - A travel-way separated from motor vehicle traffic by an open space or barrier and either within the Right-of-Way or in an independent Right-of-Way. Shared use paths may be used by pedestrians, bicyclists, and other non-motorized users. See Chapter 14 for more information on Shared Use Path Design.

Technically Infeasible - With respect to an alteration of a building or facility, something that has little likelihood of being accomplished because existing structural conditions would require removing or altering a load-bearing member that is an essential part of the structural frame; or because other existing physical or site constraints prohibit modification or addition of elements, spaces, or features that are in full and strict compliance with minimum requirements.

Turning Space - (see “Landing”)

Vertical Surface Discontinuities - Vertical differences in level between two adjacent surfaces.

Vibrotactile – Relaying information to the user through the perception of vibration or touch.

12.0 INTRODUCTION

Pedestrians may be present in all roadway environments. Pedestrian access, accommodation, and safety should be given full consideration during all project planning, scoping, and design. Accommodation can take many forms but most often appears as sidewalks or shared use paths. In rural areas or on roadways with limited pedestrian demand, paved shoulders and sometimes no facility at all may be an acceptable level of pedestrian accommodation. Sidewalks are not a requirement on every roadway; however, if there is evidence that pedestrian demand exists suitable pedestrian facilities shall be provided.

The Americans with Disabilities Act of 1990 (ADA) was the nation's first comprehensive civil rights law and prohibits discrimination against people with disabilities. Under Title II of the ADA and Section 504 of the Rehabilitation Act of 1973 (504), entities that are responsible for roadway and pedestrian facilities may not discriminate on the basis of disability in any transportation program, activity, service, or benefit which is provided to the general public. In other words, entities responsible for transportation infrastructure must ensure that people with disabilities have equitable opportunities to use the infrastructure that is provided to the public. The ADA accessibility requirements apply throughout the entire transportation facility lifecycle including planning, design, construction, maintenance, and operation.

Where pedestrian facilities are provided, they must be constructed so they are accessible to all potential users. This Chapter provides guidance and direction regarding the requirements for the design of accessible pedestrian facilities.

Under the ADA, the Department of Transportation (DOT) and the Department of Justice (DOJ) are responsible for issuing and enforcing accessibility standards. The standards are developed by the US Access Board, which is an independent agency that promotes equality for people with disabilities and is the leading source of information on accessible design. The US Access Board's guidelines become enforceable once they are adopted by the respective standard setting agency, which in the case of transportation facilities is the DOT.

To ensure that people with disabilities have access to the built environment the US Access Board developed design guidelines known as the ADA Accessibility Guidelines (ADAAG). However, pedestrian infrastructure in the public right-of-way can pose many challenges to accessibility, and the ADAAG was developed with a focus on providing accessible buildings and facilities. Although the ADAAG does address some features found within the public right-of-way it was determined that additional guidance was necessary to address conditions and constraints that are unique to public rights-of-way. The additional guidance developed was titled the Public Rights-of-Way Accessibility Guidelines (PROWAG). These draft guidelines are not standards until adopted by the DOJ and the DOT. However, the PROWAG is currently recommended as best practice by the FHWA ([January 2006 FHWA memo](#)) and can be considered the state of practice for areas not fully addressed by the ADAAG.

Both the ADAAG and the PROWAG provide the means to meet the requirements of the ADA. Generally, facilities located within the public right-of-way should be consistent with the

requirements set forth in the PROWAG. Once the PROWAG is adopted by the DOJ and the DOT it becomes the enforceable standard for transportation facilities under Title II of the ADA. The guidance in this chapter is based upon the PROWAG requirements, and references to the PROWAG document are shown in parentheses (for example - R202.3).

More information on the ADAAG and the PROWAG can be found at:

<https://www.access-board.gov/guidelines-and-standards/buildings-and-sites/about-the-ada-standards/ada-standards>

<https://www.access-board.gov/guidelines-and-standards/streets-sidewalks>

12.1 ADA ACCESSIBILITY REQUIREMENTS, STANDARDS & GUIDELINES

The ADAAG and the PROWAG are not requirements of the ADA, but serve as the standards and guidelines by which compliance of the law is measured. Generally, the ADA law requires:

- New construction to be accessible
- Alterations to existing facilities that are within the scope of a project to provide accessibility to the maximum extent feasible
- Existing facilities that have not been altered shall not deny access to persons with disabilities

New Construction Project Requirements

All new construction projects where a pedestrian demand is exhibited shall incorporate appropriate pedestrian facilities that are accessible to persons with disabilities. New construction projects have the ability to mitigate constraints through good planning and design practices. Project budget or limited scopes are not an acceptable reason to fail to provide compliant accessible facilities during new construction.

Alteration Project Requirements

Whenever existing facilities are altered, each altered element must meet the most current accessibility standard if it is within the scope of the alteration project. If elements are within a project's limits and scope but are not accessible, they must be made so. For example, if a project is resurfacing a roadway and curb ramps are missing at pedestrian crossings, compliant curb ramps must be incorporated into that project because that project affected the crossing served. That same project would not be required to install pedestrian push buttons if the existing signals are to remain, because that work is outside of the original resurfacing scope.

Where existing physical constraints make it impractical for facilities to comply with the current standard, improvements must be made to provide accessibility to the maximum extent practical within the scope and limits of the project. Alteration projects shall not intentionally skip or "gap" pedestrian elements to avoid triggering the requirement to make ADA improvements.

Only the altered portion of a facility is required to be made compliant at the time of a project. If elements are altered or added but the pedestrian circulation path is not altered, the pedestrian circulation path is not required to be made accessible. However, it is often beneficial to improve surrounding unaltered facilities while construction forces are mobilized. When possible, consideration should be given to making nearby facilities accessible. The alteration of a facility may affect the usability of an adjoining facility and additional improvements can at times be unavoidable. An alteration project shall not decrease accessibility, or the accessibility to a connecting or adjacent building or site, below the current standards required of new construction during the time of the alteration (R202.3). These considerations should be taken into account during project scoping.

If the State Historic Preservation Office (SHPO) determines that an alteration that is required for compliance would threaten or destroy historically significant features of a qualified facility, improvements shall be made to the extent that they do not destroy the historically significant features of that facility (R202.3.4).

All alteration projects must remove existing pedestrian access barriers. For example, projects must install curb ramps at locations where they are missing if they are within the limits of the altered area.

Examples of Alteration projects include, but are not limited to:

- Addition of new layers of Asphalt
- Mill and Fill / Mill and Overlay
- Rehabilitation & Reconstruction
- Cape Seals
- Microsurfacing and thin lift overlays
- Widening
- Bridge projects

For more information regarding what treatments or combinations thereof constitute alterations see the DOT's technical assistance information (links below). The DOT has prepared the graphic below to help illustrate what items may be considered maintenance versus alterations. If two maintenance items are performed at the same time, they may rise to the level of an alteration. The technical assistance from the DOT should be consulted when determining whether an item(s) is considered maintenance or an alteration.

Pavement Treatment Types (Maintenance vs. Alteration)		
MAINTENANCE		
Chip Seals	Fog Seals	Scrub Sealing
Crack Filling and Sealing	Joint Crack Seals	Slurry Seals
Diamond Grinding	Joint repairs	Spot High-Friction Treatments
Dowel Bar Retrofit	Pavement Patching	Surface Sealing
ALTERATION		
Addition of New Layer of Asphalt	Mill & Fill / Mill & Overlay	
Cape Seals	New Construction	
Hot In-Place Recycling	Open-graded Surface Course	
Microsurfacing / Thin-Lift Overlay	Rehabilitation and Reconstruction	

1. https://www.fhwa.dot.gov/civilrights/programs/doj_fhwa_ta.cfm
2. https://www.fhwa.dot.gov/civilrights/programs/doj_fhwa_ta_glossary.cfm
3. https://www.fhwa.dot.gov/civilrights/programs/ada_resurfacing_qa.cfm

Non-Alteration Project Requirements

Activities that are considered normal maintenance do not require simultaneous improvements for accessibility under the ADA. The DOT has offered the following guidance regarding what kinds of treatments constitute regular maintenance activities as opposed to an alteration:

*“Treatments that serve solely to seal and protect the road surface, improve friction, and control splash and spray are considered to be maintenance because they do not significantly affect the public's access to or usability of the road. Some examples of the types of treatments that would normally be considered maintenance are: painting or striping lanes, crack filling and sealing, surface sealing, chip seals, slurry seals, fog seals, scrub sealing, joint crack seals, joint repairs, dowel bar retrofit, spot high-friction treatments, diamond grinding, and pavement patching. **In some cases, the combination of several maintenance treatments occurring at or near the same time may qualify as an alteration and would trigger the obligation to provide curb ramps.**”*
(Emphasis added)

Generally, maintenance activities are considered those actions that are intended to preserve the functionality or condition of an asset without increasing its capability or structural capacity.

Emergency repairs, such as interim paving or patching, would not trigger the requirement to upgrade or install accessible pedestrian facilities.

Technically Infeasible

It can be impractical to make facilities fully compliant with the standards due to existing site constraints. Improvements at locations can be deemed “Technically Infeasible” when sound engineering judgement is exercised. When full compliance is deemed technically infeasible, facilities being altered should be made accessible to the maximum extent practicable. If a site cannot meet accessibility standards, the proper documentation procedures should be followed. For more information, visit CDOT’s Civil Rights ADA Resources for Civil Engineers webpage. For example, should a hypothetical curb ramp be constrained by a historic property, CDOT staff should visit the Civil Rights ADA Resources for Civil Engineers webpage and download the **Curb Ramp Variance Support Document** in order to prepare documentation for the affected ramp. Curb Ramp Variance Support Documents should be initiated as early as possible on projects so one ramp does not hinder the project schedule.

Examples of site constraints that may make it technically infeasible to make a facility fully compliant include:

- Underground structures or utilities that would have to be altered to make a facility compliant and would expand the project scope.
- Adjacent development or buildings that would need to be moved or altered to make a facility fully compliant.
- Required improvements that would alter the status of a Historic property.
- Drainage that could not be maintained if an area is made fully accessible.
- Underlying terrain that would require significant expansion of the project scope to achieve full compliance. An example would be altering a roadway profile to make the cross slope of a crosswalk fully compliant.

Project scope, not cost, should determine when existing constraints make an item technically infeasible. For example, a resurfacing project that does not include the relocation of existing utilities may be justified in providing a facility that does not comply fully with the standards and is accessible to the maximum extent feasible if those utilities prohibit compliance. However, a widening project that includes right-of-way acquisition and utility relocations would not be able to use that same justification because those elements are within the scope of the project.

Unaltered Existing Facilities & Transition Plan

Facilities that are not to be addressed in any current or planned CDOT projects are to be addressed through CDOT’s ADA Transition Plan. For more information about the plan and to access the plan itself visit <https://www.codot.gov/business/civilrights/ada/transition-plan>

12.2 TECHNICAL REQUIREMENTS FOR ACCESSIBILITY

The following section provides detailed technical criteria and guidance for the development of accessible pedestrian routes. The material in this section is derived from information found in the PROWAG and other relevant sources. It is the intent of this Chapter to be consistent with all of

the criteria provided in existing federal or CDOT standards. This section is intended to provide the most relevant technical requirements in one location and provide additional guidance and best practices when possible. The minimum and maximum values that are provided are taken from the PROWAG. Target values may also be provided. **Designing features to values other than the allowable minimums or maximums allows for adjustments in the field and provides flexibility during construction.** This practice is encouraged when possible.

Pedestrian Access Route Technical Requirements

A pedestrian access route (PAR) is a continuous and unobstructed path of travel intended to provide accessibility for pedestrians with disabilities. A pedestrian access route shall be provided where a prepared surface has been constructed for pedestrian travel within the right-of-way. Examples of areas that may be considered a PAR include:

- Crosswalks at intersections
- Curb ramps
- Pedestrian overpasses and underpasses
- Sidewalks
- Shared-use paths
- Elevators
- Doorways
- Parking access aisles.

The following describes the common requirements of the PAR.

Continuous Width (R302.3) - The continuous width of the PAR shall be 4 feet minimum, exclusive of the curb. Where a pedestrian access route makes a 90 degree turn, it should be widened to 5 feet to accommodate the continuous passage of a wheelchair (i.e. pedestrian design vehicle). CDOT projects should provide 5-foot sidewalks unless unique constraints are present. If the clear width of the PAR is less than 5 feet, passing spaces shall be provided at a maximum of 200-foot intervals. If passing spaces are provided they shall be 5 feet by 5 feet minimum. The clear width of a pedestrian refuge island shall be 5 feet minimum.

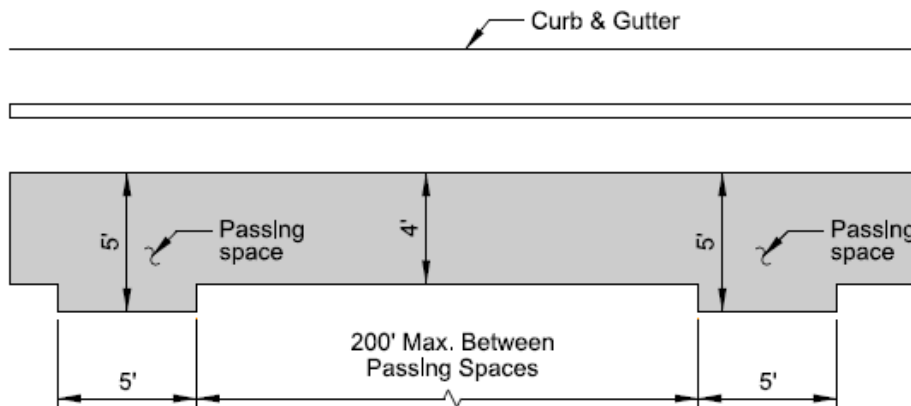

Figure 12-1 - Passing Spaces

Pinch Points - Pinch points within the PAR shall not be less than 34 inches in width and not exceed 24 inches in the direction of pedestrian travel. A study by the U.S. Access Board determined that a 34 inch width allowed 95% of the wheel mobility users to pass the obstruction in the study areas (Anthropometry of Wheel Mobility Project, US Access Board). Pinch Points are permitted in constrained areas on maintenance and alteration projects only with approval of the Project Engineer. **Pinch points are not acceptable in new construction.**

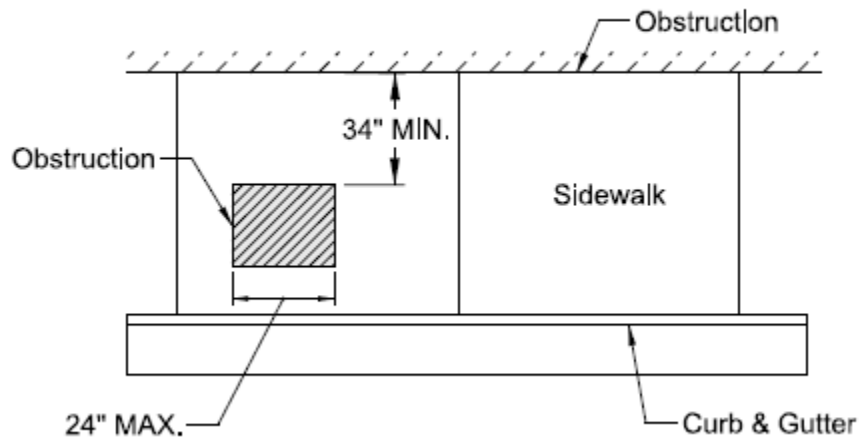

Figure 12-2 - Pinch Points

Surface (R302.7) - The surface of the PAR must be firm, stable, and slip resistant. A standard test has not been defined to measure slip resistance or stability, so sound engineering judgement must be applied to ensure that users with mobility impairments can traverse the PAR. The preferred surface for pedestrian walkways and sidewalks is concrete with a transverse broom finish. Examples of noncompliant surfaces include cobblestones, split-faced stone, loose sand, dirt, gravel, and any other similar irregular surface. Grade breaks along the PAR and within curb ramps shall be flush. The characteristics of the surface when wet should be taken into consideration when determining if a surface is firm, stable, and slip resistant.

There exists an allowance for vertical surface discontinuities for occasional expansion joints and objects such as utility covers, vault frames, and gratings that cannot be located in another portion of the sidewalk or outside the PAR. Objects such as utility covers, vault frames, and gratings should not be located on curb ramp runs, blended transitions, turning spaces, or gutter areas within the PAR. This may not always be possible in alterations, but should be avoided when possible. Vertical surface discontinuities between unit pavers should be minimized. Vertical surface discontinuities shall be a 0.5-inch maximum. When there is a surface discontinuity between 0.25 inch and 0.5 inch, the discontinuity shall be beveled at 2:1. The bevel shall be provided for the entire length of the discontinuity.

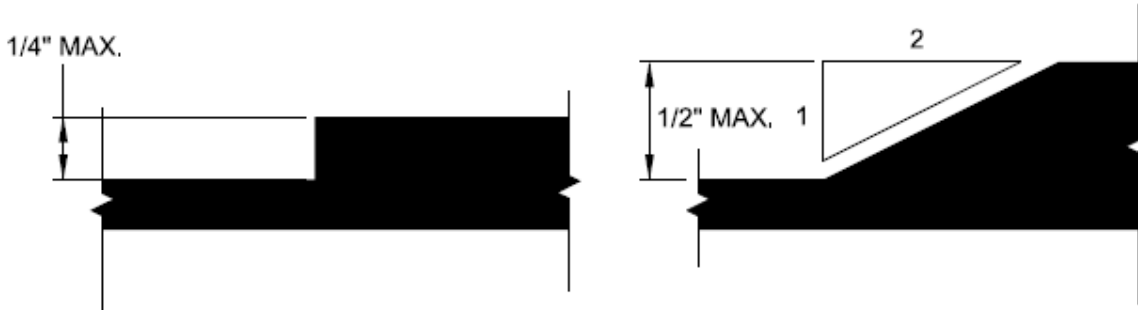

Figure 12-3 - Allowable Vertical Discontinuities

Where the PAR crosses a rail at grade, the pedestrian access route surface shall be level with the top of the rail. The surface between the rails shall be level with the top of the rails.

Horizontal Openings & Horizontal Gaps (R302.7.3) - The horizontal openings in grates shall not permit passage of a sphere more than 0.5 inch in diameter. Grate openings should be placed so that the long dimension is perpendicular to the direction of travel of pedestrians. The use of grates and inlets within the PAR should be avoided.

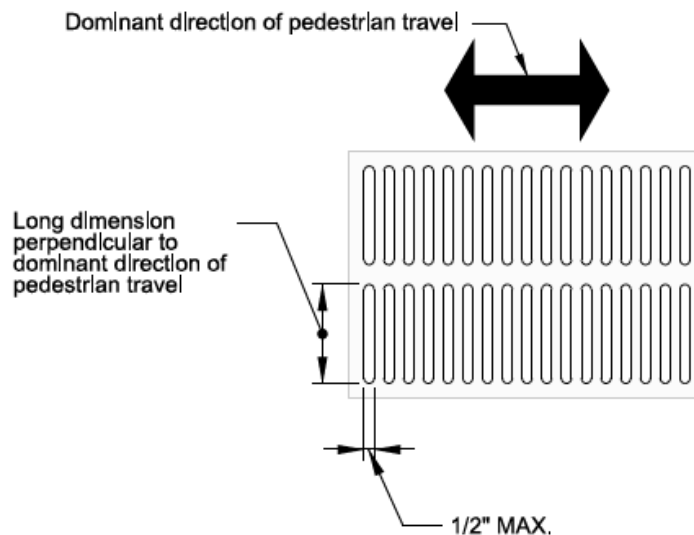

Figure 12-4 - Horizontal Openings in Grates

When the PAR crosses a railway the horizontal gap between the pedestrian surface and the rail shall be no more than 2.5 inches on a non-freight railway and no more than 3 inches on a freight railway.

Protruding Objects (R402) - Objects which are between 2.25 feet (27 inches) and 6.7 feet (80 inches) above the finished surface of the walkway shall not protrude into the pedestrian access route more than 4 inches.

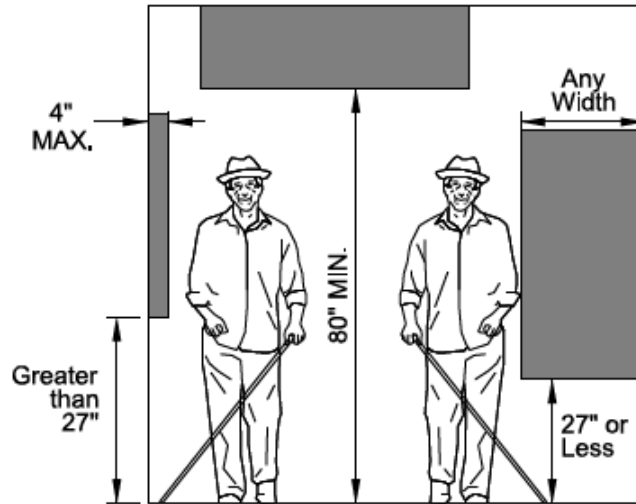

Figure 12-5 - Protruding Objects

When vertical clearance is less than 6.7 feet (80 inches), a guardrail or barrier to pedestrian travel shall be provided. The leading edge of the barrier or guardrail shall not be more than 2.25 feet (27 inches) above the finished surface.

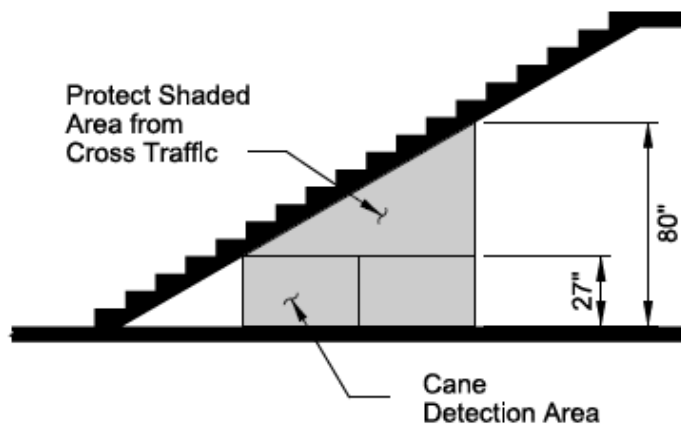

Figure 12-6 - Protection from Stairways

Grade (R302.5) - When the PAR is contained within the street or highway right-of-way the grade of the PAR can match the general grade of the street or highway. When the PAR is not within the street or highway right-of-way the grade of the PAR shall not be greater than 5.0%. The grade of the pedestrian access route is measured parallel to the dominant direction of pedestrian travel.

Cross Slope (R302.6) - The cross slope of the PAR is measured perpendicular to the dominant direction of travel and shall not exceed 2.0%.

The PROWAG has set limits for the maximum allowable cross slope at pedestrian street crossings. At these locations the roadway longitudinal grade becomes the cross slope of the pedestrian crossing. The maximum allowable cross slope for pedestrian street crossings is dependent on the type of vehicular traffic control present at the crossing. At times, these requirements limit the longitudinal grade of the roadway and require a “tabled crosswalk” at the intersection. Pedestrian crossings without yield or stop control are defined as those without a yield or stop sign, or where a traffic signal is designed to remain in the green phase. The following are the requirements for cross slope of pedestrian street crossings:

1. *Intersection leg with yield or stop control* - The pedestrian street crossing must not have a cross slope greater than 2.0%.
2. *Intersection leg without yield or stop control* - The pedestrian street crossing must not have a cross slope greater than 5.0%.
3. *Mid-block pedestrian crossing* - The pedestrian street crossing is allowed to have a cross slope equal to the street or highway grade.

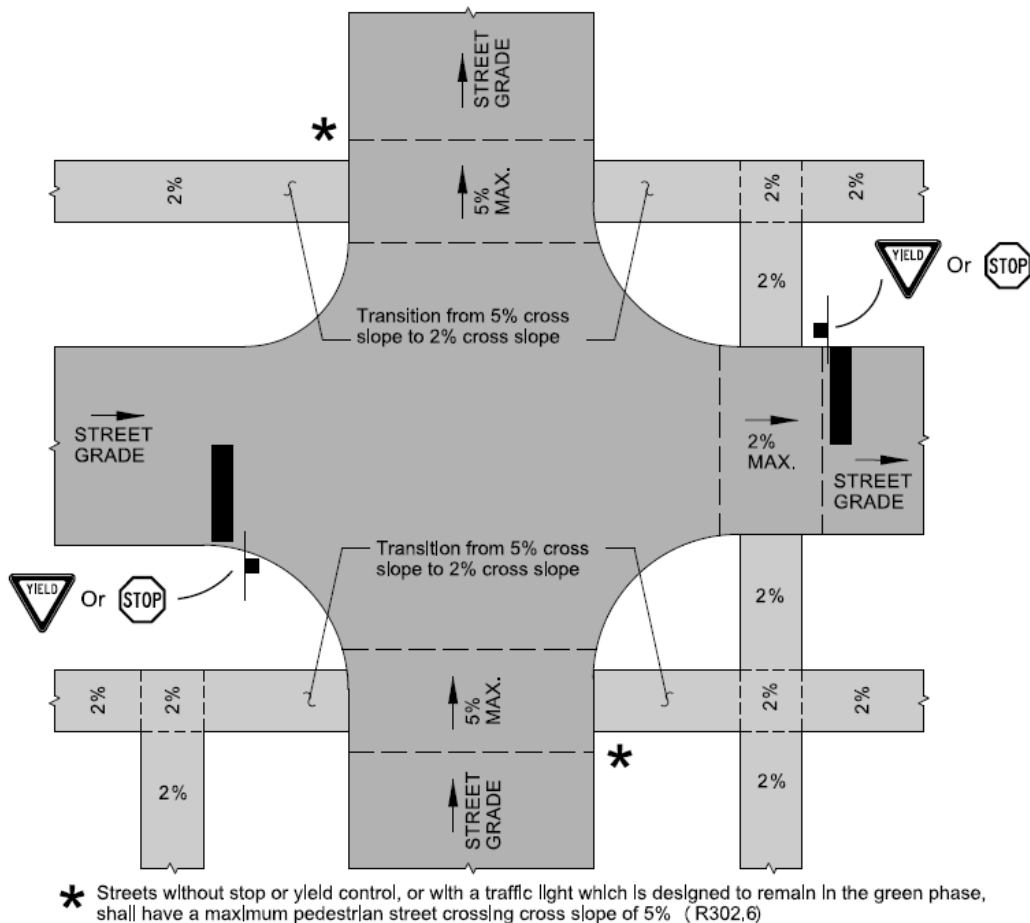

Figure 12-7 - Pedestrian Street Crossing Cross Slope

12.3 CURB RAMP GENERAL INFORMATION

Curb ramps are intended to provide pedestrians access between the sidewalk and street when a curb face or vertical change in elevation is present. For new construction or on streets being altered, curb ramps are mandated by Title II of the ADA. In addition to providing access for those with mobility impairments, curb ramps also make street crossings easier for pedestrians without disabilities including people pushing strollers, riding bicycles, and making deliveries.

Most curb ramps contain a combination of the following core elements: approach, ramp runs, flares, vertical curb faces, landings or turning spaces, transition between the ramp run and gutter, and detectable warnings. These common elements can be configured in several ways to create a variety of curb ramp designs. Generally, curb ramps can be grouped into three categories: perpendicular ramps, parallel ramps, and blended transitions.

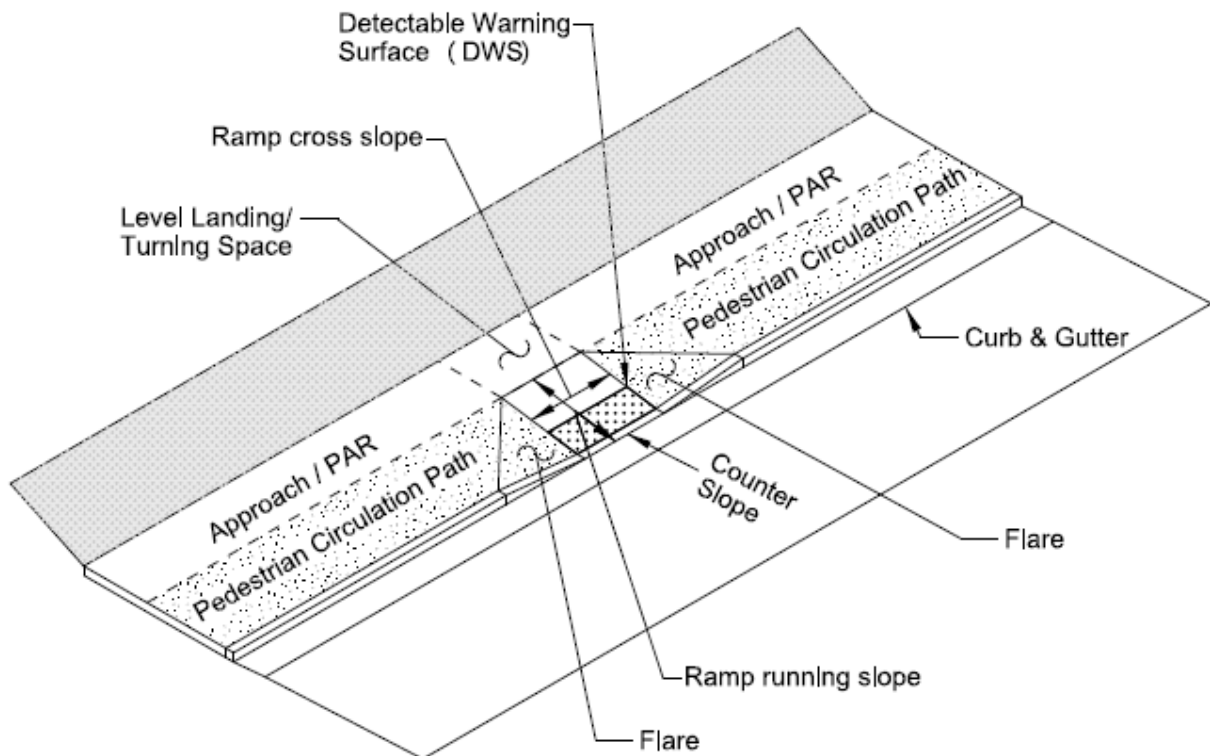

Figure 12-8 - Curb Ramp Elements

Curb ramps should not be placed in locations where pedestrians must cross drainage inlets or ponding water. Designers should consider the location of drainage inlets relative to any curb ramps that are being installed. Locating or moving drainage inlets upstream of curb ramps helps eliminate ponding and should be a consideration during design. Curb ramps should be located away from the low point of a curb return when possible.

Often curb ramp locations will be determined by the existing site constraints, however, the preferred design is to have a separate curb ramp aligned with each crossing. In new construction,

where existing constraints do not exist, one curb ramp for each crossing is required. On CDOT projects, a single diagonal curb ramp (on the apex) will only be permitted on reconstruction and alteration projects where physical site constraints prevent two curb ramps from being installed. Designers should make every attempt to provide one ramp per crossing.

Diagonal curb ramps present several challenges of which designers should be aware:

- Providing a level clear space at the bottom of a ramp is often difficult to achieve.
- Diagonal ramps present a problem for pedestrians because pedestrians are directed towards the middle of the intersection. This may be particularly troublesome for pedestrians with vision impairments who cannot determine the correct alignment of the street crossing.
- They create uncertainty for motorists who cannot determine which direction the pedestrian is trying to cross. As a result, motorists are less likely to yield to pedestrians trying to cross the street.

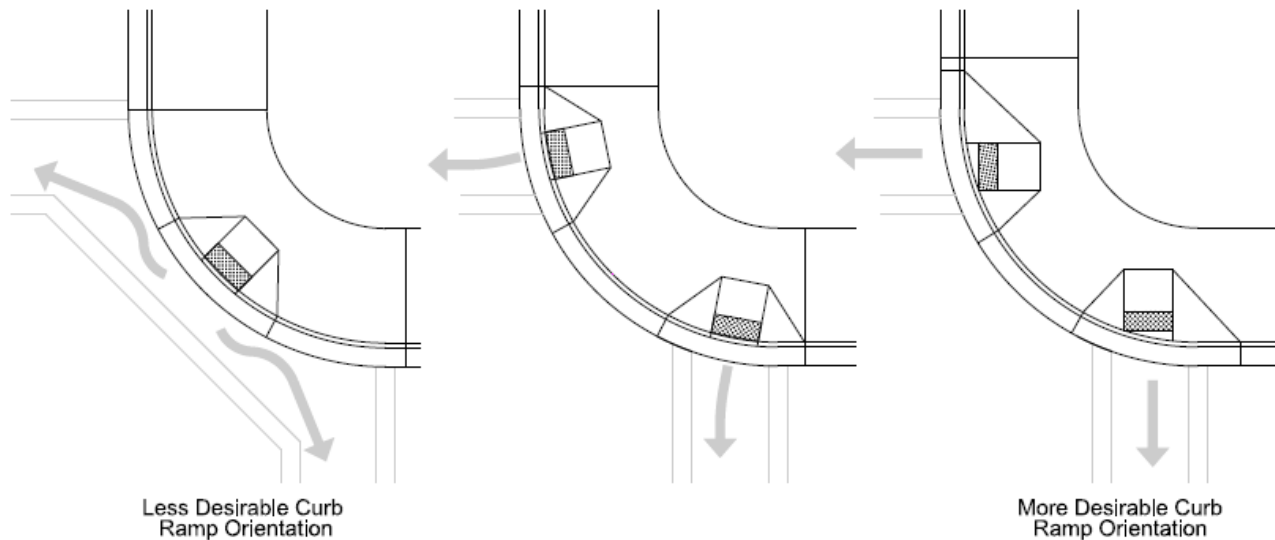

Figure 12-9 - Preferred Curb Ramp Placement

12.4 CURB RAMP TYPES

Perpendicular curb ramps are oriented perpendicular to the curb face or vertical elevation change they traverse. Perpendicular ramps have a turning space located at the top of the ramp to allow users to get oriented in the direction of the crossing before travelling down the ramp.

Perpendicular curb ramps are generally the preferred design to accommodate pedestrians if there is enough space for their installation. When possible, perpendicular ramps should be aligned with the pedestrian street crossing they serve. When space is not available for the installation of a perpendicular curb ramp consideration should be given to the use of parallel curb ramps.

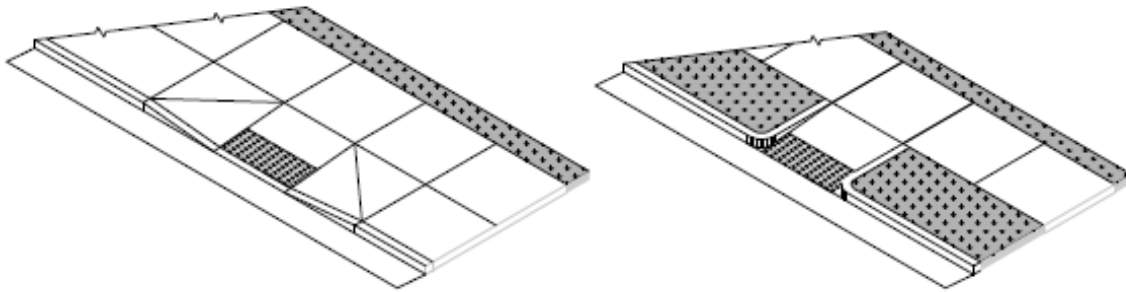

Figure 12-10 - Perpendicular Curb Ramp Examples

Parallel curb ramps are oriented parallel to the curb face or elevation change which they traverse. These are often used when there is little room between the curb and the back of sidewalk for a perpendicular curb ramp and turning space. Parallel curb ramps transition down to the roadway elevation and require individuals to traverse multiple ramp surfaces when traveling along a sidewalk. To avoid this, it is preferred that perpendicular ramps be used where possible. Additionally, because the turning space of a parallel ramp is at the roadway grade, sedimentation and drainage can be an issue with parallel style curb ramps.

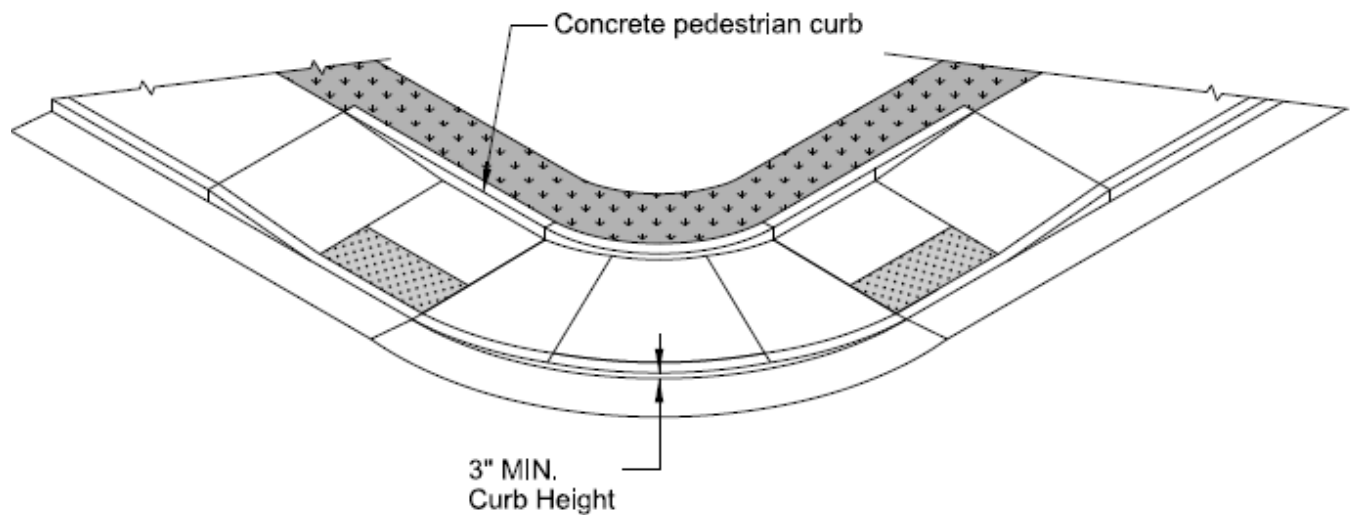

Figure 12-11 - Parallel Curb Ramp Example

In a blended transition the elevation of the sidewalk is slowly lowered to the street level at the corner. The maximum grade of a blended transition is 5.0% and the maximum cross slope is 2.0%. Blended transitions are typically seen in dense urban areas such as central business districts, around stadiums, or in main street environments. Blended transitions present an opportunity for turning vehicular traffic to traverse the sidewalk and thereby pose a safety risk to pedestrians. Blended transitions also create challenges for the visually impaired because they provide limited directionality. Blended transitions should be used sparingly, and only where appropriate.

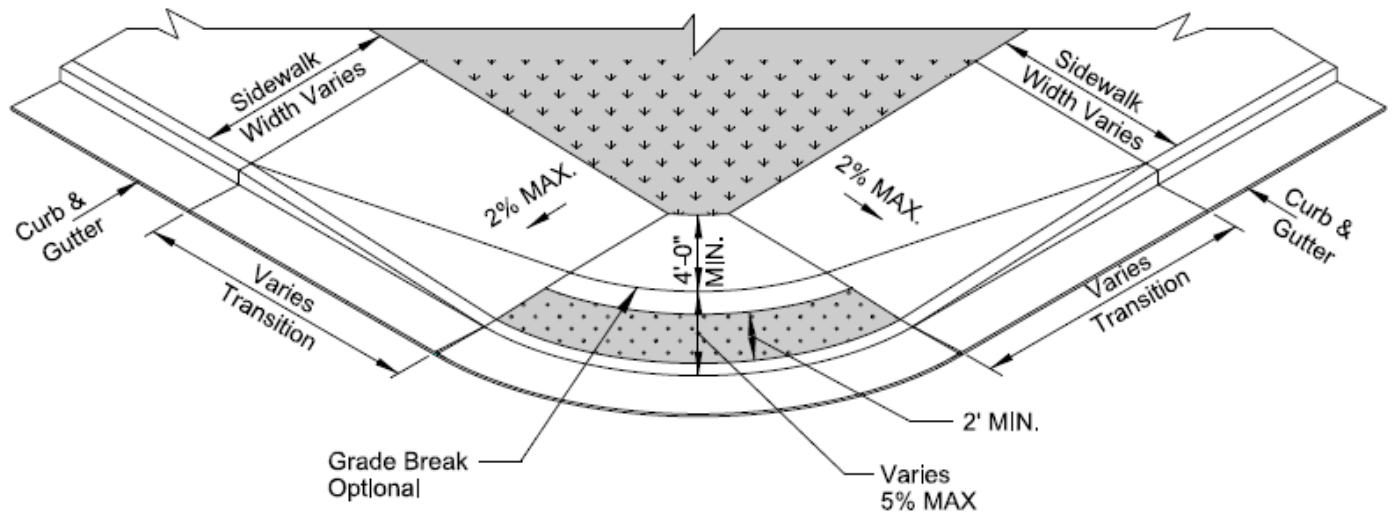

Figure 12-12 - Blended Transition/Depressed Corner Example

12.4 CURB RAMP TECHNICAL REQUIREMENTS

Although there are several types and configurations of curb ramps, including combinations of the types mentioned above, they all have the following general requirements:

Ramp Running Slope (R304.2.2) - Curb ramps shall have a maximum running slope of 8.33%. The running slope of a curb ramp is measured in the center of the ramp run in the direction of pedestrian travel. If the surrounding terrain requires a ramp to chase grade, the ramp is required to be no longer than 15 feet, regardless of the resulting slope. **Designers should target a running slope of 7.5% to provide for flexibility during construction.** Designing to the maximum allowable slopes does not leave any flexibility to those who must construct curb ramps in the field. The running slope of a turning space shall be 2.0% maximum.

Ramp Cross Slope (R304.5.3) - The maximum cross slope of a curb ramp shall be 2.0%. **Designers should target a cross slope of 1.5% to provide for flexibility during construction.** For street crossings that do not have stop or yield control, or at mid-block crossings, the cross slope is allowed to match the street or highway grade. See the PAR cross slope requirements for more information.

Ramp Width (R304.5.1) - The clear width of curb ramp runs, turning spaces, and blended transitions shall be 4 feet minimum. On CDOT projects, curb ramp runs, turning spaces, and blended transitions should be 5 feet in width. If the sidewalk the curb ramp is servicing is wider than 5 feet the ramp should match the width of the facility it is servicing. Curb ramps that service shared-use paths should match the width of the path.

Grade Breaks (R304.5.2) - Grade breaks at the top and bottom of curb ramp runs shall be perpendicular to the ramp. Grade breaks are not allowed on the surface of the ramp run or turning space. Surfaces that meet at grade breaks shall be flush. When grade breaks are not

perpendicular to the path of travel they pose challenges to users in wheelchairs because one wheel may strike the ramp before the others.

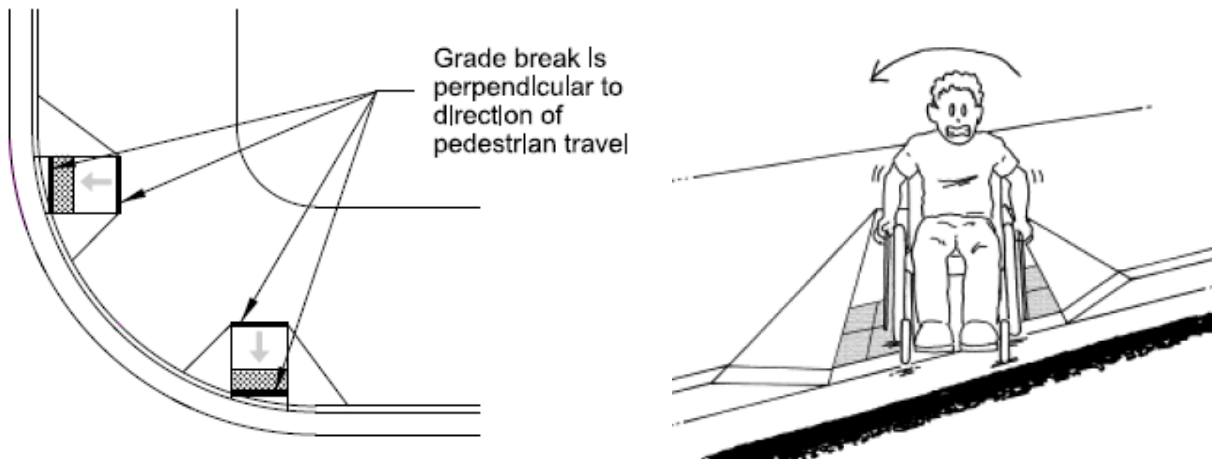

Figure 12-13 - Curb Ramp Grade Breaks

Turning Spaces (R304.2.1 & 304.3.1) - Turning spaces allow users to maneuver on and off the curb ramp and are required at the top or bottom of a curb ramp. Turning spaces are required at the top of a perpendicular curb ramp and at the bottom of a parallel curb ramp. The maximum running slope and cross slope of turning spaces shall be 2.0%. **Designers should target slopes of 1.5% to provide flexibility during construction.** At mid-block crossings or locations without yield or stop control, the cross slope of the turning space is allowed to equal the street or highway grade (R302.6). Turning spaces shall be 4 feet by 4 feet minimum. If the turning space is constrained by a vertical element on one or more sides, provide 5 feet in the direction of the street crossing.

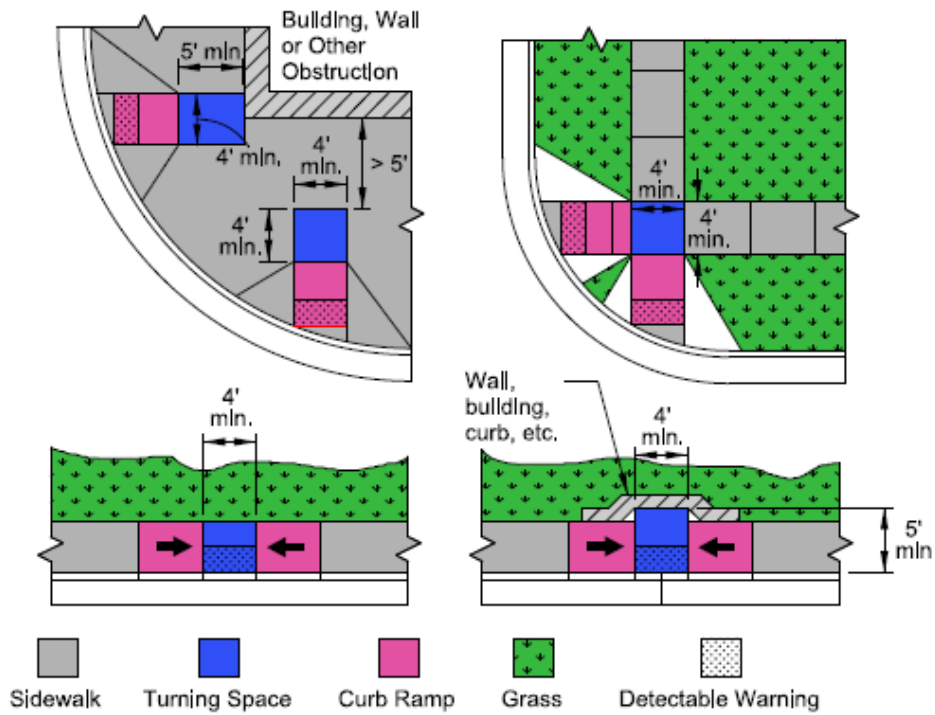

Figure 12-14 - Curb Ramp Turning Spaces

When the profile of the roadway being crossed has an excessive slope, the curb ramp cross slope should be transitioned slowly to the turning space. The transition shall be spread evenly over the length of the curb ramp.

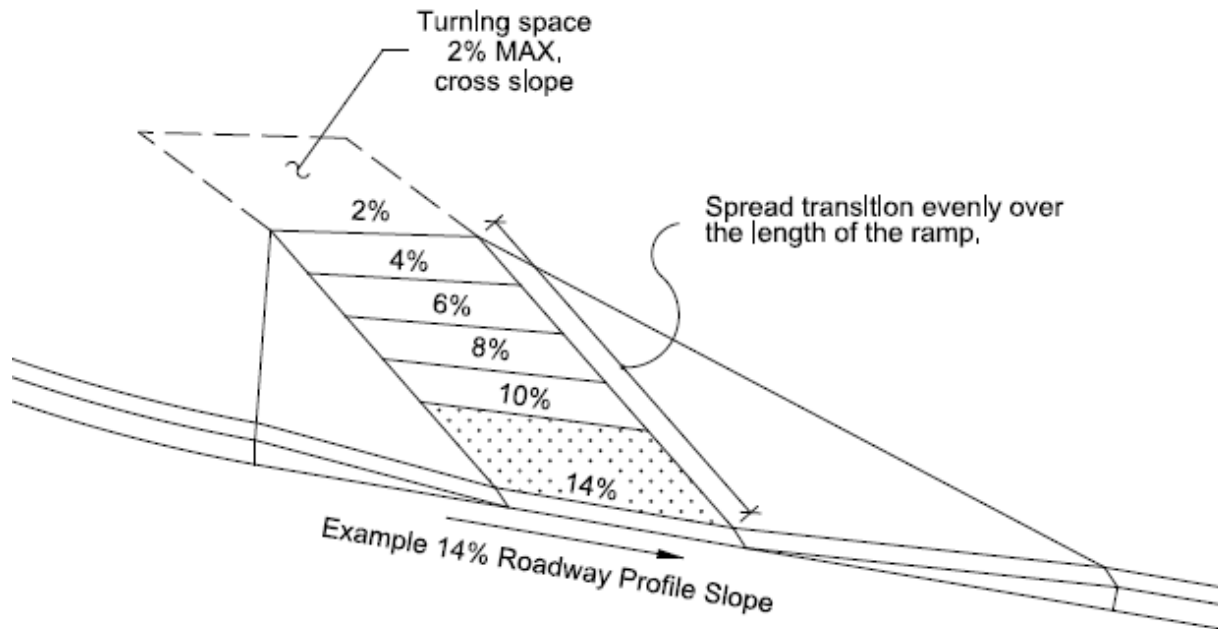

Figure 15 - Transitioning Steep Roadway Slopes

Clear Spaces (R304.5.5) - Beyond the bottom grade break of perpendicular ramps, a clear space 4-foot by 4-foot minimum shall be provided. This clear space must be within the pedestrian street crossing (crosswalk) and wholly outside of any vehicle travel lanes.

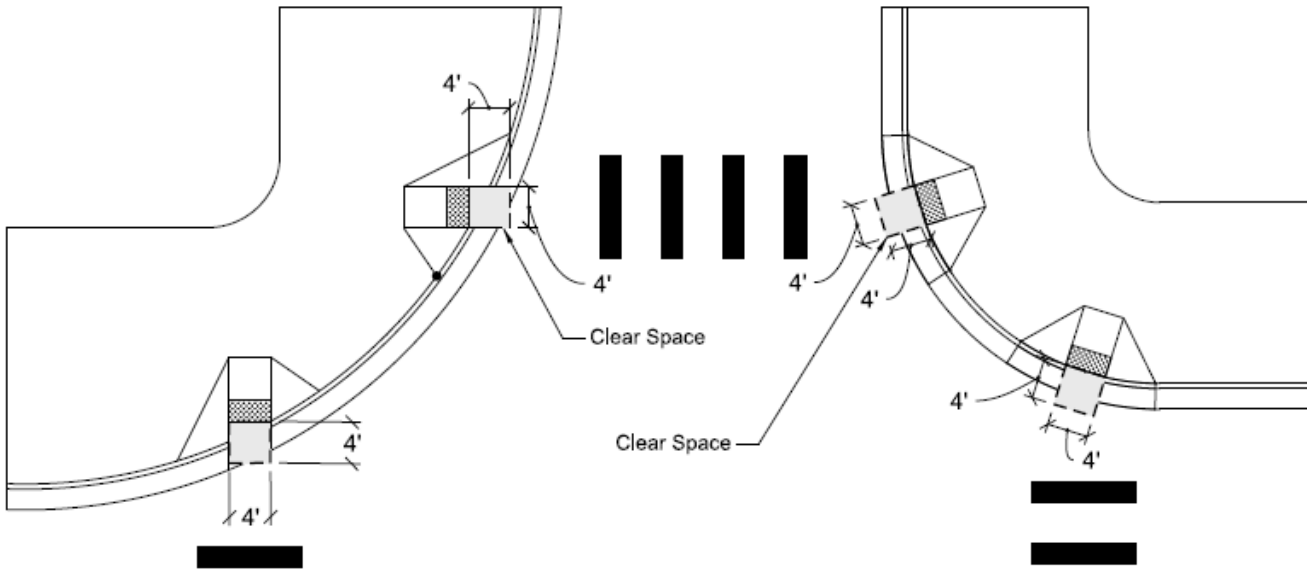

Figure 12-16 - Perpendicular Curb Ramp Clear Spaces

Flared Sides (R304.2.3) - Where a pedestrian can walk across a curb ramp, flared sides shall be provided to prevent a tripping hazard. Flared sides shall be sloped at 10.0% maximum and be measured parallel to the curb line. **A best practice is to design flares with slopes between 8.0% and 10.0%**, this helps clearly define the curb ramp from the sidewalk. Flared sides are only required where the curb ramp abuts a portion of a pedestrian circulation path. If access to a ramp flare is blocked from pedestrian travel by an item such as street furniture or a utility, then the flare slope may exceed 10%.

A vertical curb face may be used if the ramp abuts a non-walkable surface. Vertical curb faces can be beneficial to pedestrians with visual disabilities because they align pedestrians in the direction of the street crossing. Flared sides may be used when the ramp abuts a non-walkable surface, in this situation the allowable slope of the flare is at the designer's discretion. Using flared sides can be beneficial in protecting the ramp from vehicle strikes such as from snowplows, however, they do not provide the directionality benefits that vertical faces do.

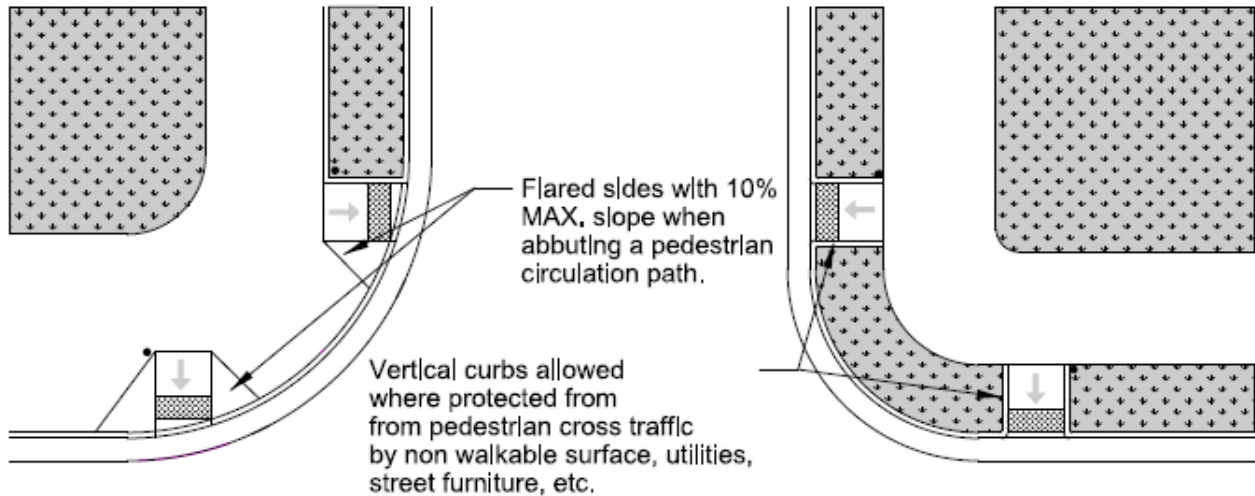

Figure 12-17 - Flared Sides

Counter Slope - The transition from the curb ramp to the roadway surface must be flush. The counter slope of gutter or street must be 5.0% or less. The algebraic difference of the ramp run and the street counter slope shall not exceed 13.33%. A rapid change in grade at the bottom of a ramp run can be difficult for wheelchair users to traverse. A best practice is to limit the algebraic difference between the ramp run and the counter slope to 11.0%, unless special accommodations are made. If the algebraic difference of the ramp and the counter slope exceeds 11.0%, a level strip should be provided to ease the transition from the ramp to the street.

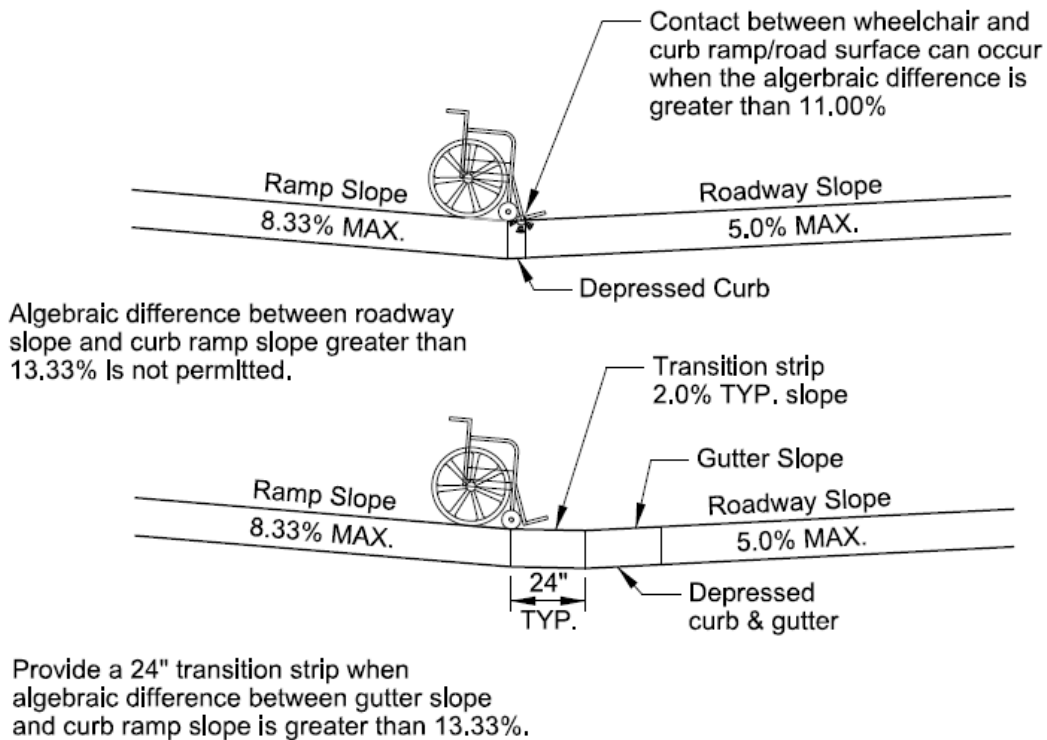

Figure 12-18 - Curb Ramp Counter Slope Requirements

12.5 DETECTABLE WARNING SURFACES

Detectable warning surfaces (DWS) provide an indication to individuals with disabilities that they are entering a potentially dangerous area. This is communicated through a distinct patterned surface consisting of truncated domes. DWS should be detectable by cane or underfoot and are intended to differentiate the boundary between the pedestrian realm and vehicular routes when a raised curb face is missing. DWS provide a cue to pedestrians with visual impairments and are required to contrast visually with the surrounding surface (light on dark or dark on light).

The truncated dome pattern of the DWS should be aligned so that the rows of domes are parallel to the direction of pedestrian travel. This alignment allows users in wheelchairs to more easily track between the domes and avoid excessive vibration, which can be uncomfortable to individuals with a spinal cord injury. The orientation of the truncated domes is not intended to provide wayfinding assistance (orient users in the direction of the crossing) for pedestrians with visual disabilities. While a best practice, this is not a requirement and cannot always be accomplished.

DWS shall extend 2 feet in the direction of pedestrian travel and are typically placed at the back of curb. DWS shall extend the full width of a curb ramp (excluding flared sides), blended transition, or turning space. DWS shall extend the full width of pedestrian rail crossings or shared-use path crossing. At boarding platforms for railways or buses, DWS shall be placed along the full length of the platform. At boarding areas at the sidewalk or street level the DWS shall extend the full length of the transit stop. When a border is required for installation, such as when pavers are used, the border shall be no more than 2 inches in width.

For the technical requirements of the truncated dome size and spacing, see the PROWAG section R305.1 or CDOT Standard Plan M-608-1.

Of the DWS allowed on CDOT projects, pavers require the most ongoing maintenance over time. This should be considered when specifying their usage on a project.

Placement - Detectable warning surfaces must be installed at all pedestrian street and rail crossings (R208.1). The PROWAG advises where DWS should be placed in Advisory R208.1. It recommends that DWS not be placed at residential driveway crossings or at locations where the pedestrian right-of-way continues across driveway aprons. However, it does recommend that DWS be placed at commercial driveways when yield or stop control is present. This guidance is not necessarily comprehensive and may be confusing to designers. For example, small commercial centers might have less driveway traffic than large apartment complexes but require DWS. Sound engineering judgement should be applied regarding the application of DWS at driveway crossings. Conditions that make a driveway function more like a street crossing may warrant the use of DWS, regardless of the land use category. Types of driveway locations that may warrant the use of DWS include:

- If there is the presence of a traffic control device that indicates the driveway functions more like a street crossing than a driveway (e.g. lane or pavement markings, signals, stop signs).
- Where a sidewalk descends to meet the grade of the street at the driveway crossing.
- Where the sidewalk changes material and ceases to be clearly defined as sidewalk, for example changing from concrete sidewalk to asphalt that looks more similar to the street at the driveway.

Parallel Curb Ramps - On parallel curb ramps the DWS shall be placed in the turning space at the back of curb where the curb face is missing.

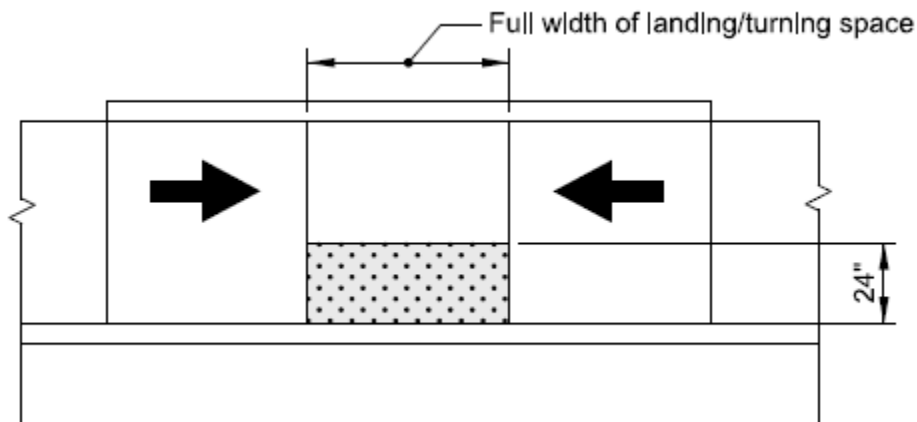

Figure 12-19 - Parallel Curb Ramp DWS Placement

Perpendicular Ramps - The placement of the DWS on perpendicular curb ramps varies depending on the location of the grade break at the bottom of the ramp. Generally, the DWS is placed at the back of curb where the curb face is missing. In situations where the ramp is located on a radius and the grade break at the bottom of the ramp is less than 5 feet from the back of curb, the DWS is placed at the bottom of the ramp (see Figure 20).

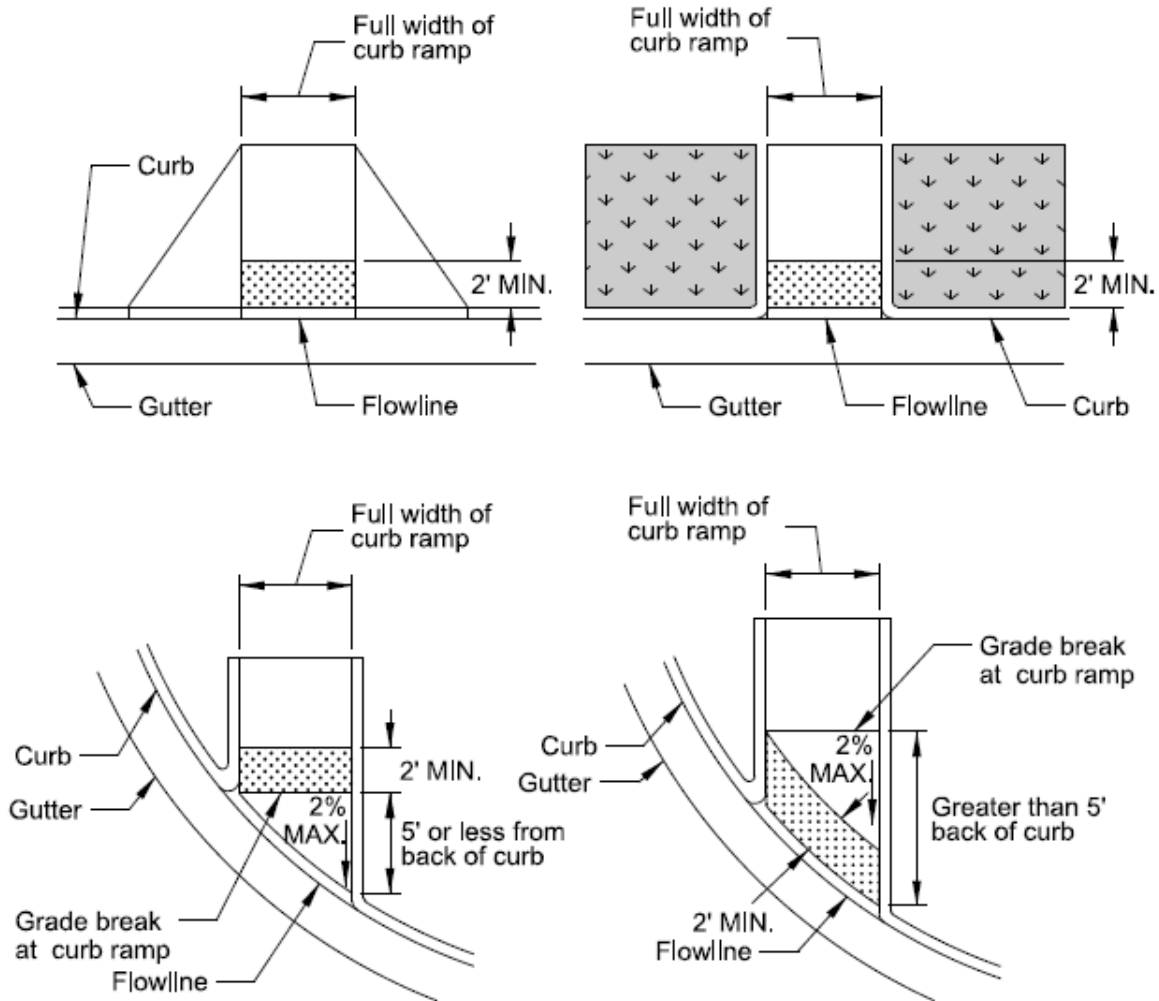

Figure 12-20 - Perpendicular Curb Ramp DWS Placement

Pedestrian Refuge Islands - When a pedestrian refuge island is 6 feet wide or greater from the face of curb to face of curb, DWS shall be installed. When installed the detectable warning surfaces must be separated by a surface without DWS that is a minimum of 2 feet in length (parallel to pedestrian travel). If this 2-foot space cannot be provided, DWS shall not be installed because the island is not wide enough to be considered a pedestrian refuge.

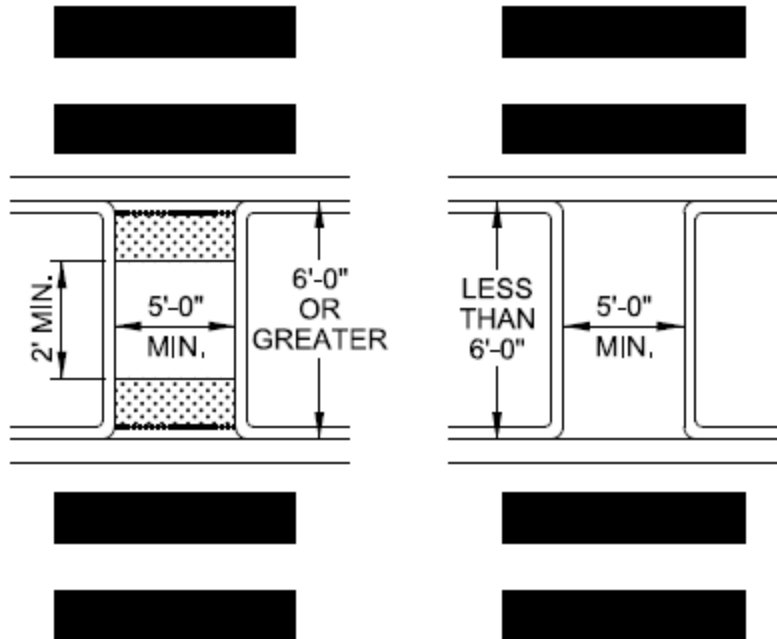

Figure 12-21 - Pedestrian Refuge DWS Placement

Railroad Crossings - When pedestrian rail crossings are not within the street or highway, detectable warning surfaces shall be placed on each side of the rail crossing. The DWS shall be a minimum of 6 feet from the nearest rail and a maximum of 15 feet from the nearest rail. If pedestrian crossing gates are present, the DWS shall be placed so that the pedestrian encounters the DWS before the crossing gate when traveling toward the rail crossing.

12.6 PEDESTRIAN CROSSING CONTROLS

When pedestrian activated crossing controls are provided they must meet the requirements set forth in the MUTCD, specifically sections 4E.08 through 4E.13. An accessible pedestrian signal (APS) is a device that communicates information to pedestrians about the street crossing through audible tones and vibrotactile surfaces. Operable parts on items such as pedestrian push buttons and APS shall comply with section R403 of the PROWAG.

Consistency throughout the pedestrian system is critical. On CDOT signal projects each location should be evaluated to determine if there is a need for APS through the application of CDOT's APS protocol.

https://www.codot.gov/business/civilrights/ada/assets/cdot_aps_protocol_march_2017.pdf

In addition to the requirements in the MUTCD and the PROWAG, the following should be taken into consideration when installing pedestrian crossing controls for pedestrian accessible routes:

- Pedestrian push buttons should be located as close as practical to the curb ramp they are servicing while at the same time permit operation from a clear and level space.

- The pedestrian push button location should not interfere with the use of the curb ramp or the sidewalk.
- If a push button cannot be practically located within the recommended area, consider moving it back and adjusting the pedestrian crossing time.
- Do not place the push button pole in the pedestrian access route.
- Pedestrian push buttons shall be mounted between 15 and 48 inches above the surface from which they are being accessed; the preferred mounting height is 42 inches.
- Pedestrians should not have to reach more than 10 inches to access a push button.
- A firm, stable, slip resistant surface must be provided to allow for a forward or parallel reach to the pedestrian push button from a wheelchair.
- Pedestrian push buttons should not be placed adjacent to the running slope of a curb ramp.
- Pedestrian push buttons should be located on the side of the pole from which the pedestrian accesses the button. Pedestrians should not have to reach around the pole to access the button.

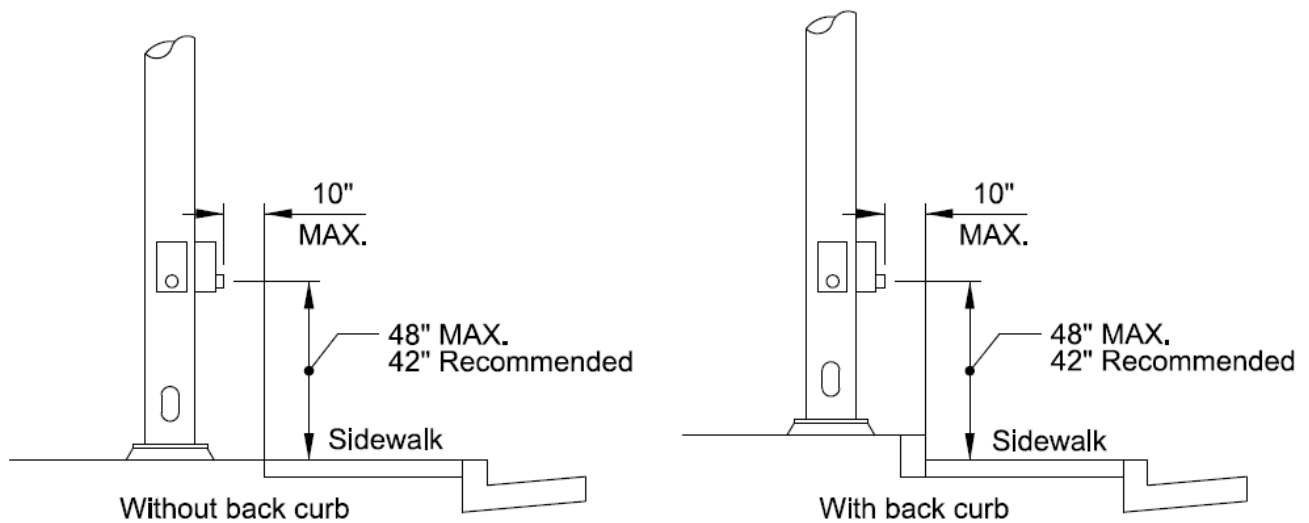

Figure 12-22 - Ped Push Button Reach Ranges

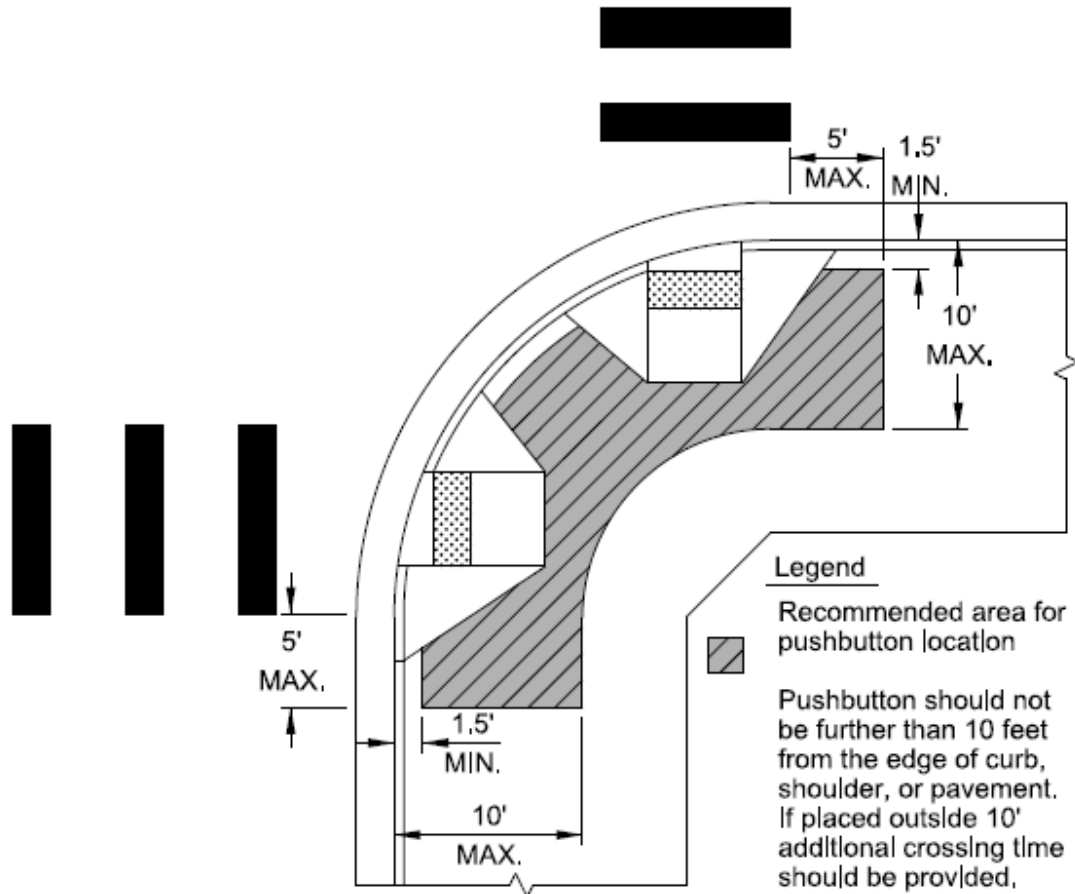

Figure 12-23 - Ped Push Button Placement

12.7 PEDESTRIAN RAMPS & LANDINGS

Pedestrian ramps that traverse changes of elevation should use a running slope between 5.0% and 8.33%. Where possible, the flattest running slope should be used to accommodate the widest possible range of users. Wheelchair users with disabilities affecting their arms, or individuals with low stamina, can have difficulties using pedestrian ramps. For this reason level landing areas are provided at regular intervals on pedestrian ramps. The vertical rise of any ramp run shall not exceed 30 inches without a level landing space. Ramps shall have level landing spaces at both the top and the bottom of each ramp run. Landing spaces should be 5 feet in length and match the width of the ramp. If the landing space is located at a 90-degree turn in the ramp it should have a minimum dimension of 5 feet by 5 feet.

Any ramp with a vertical rise greater than 6 inches shall provide handrails. The requirements for pedestrian handrails are described in detail in Section R409 of the PROWAG.

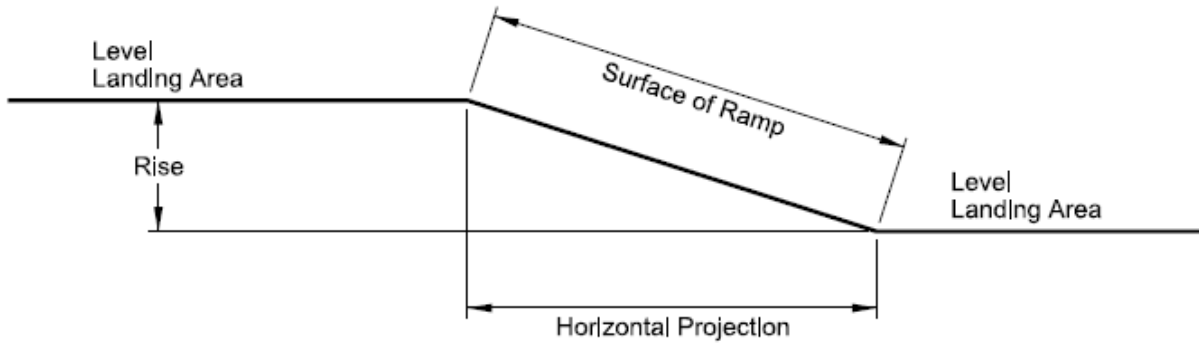

Figure 12-24 - Pedestrian Ramp Elements

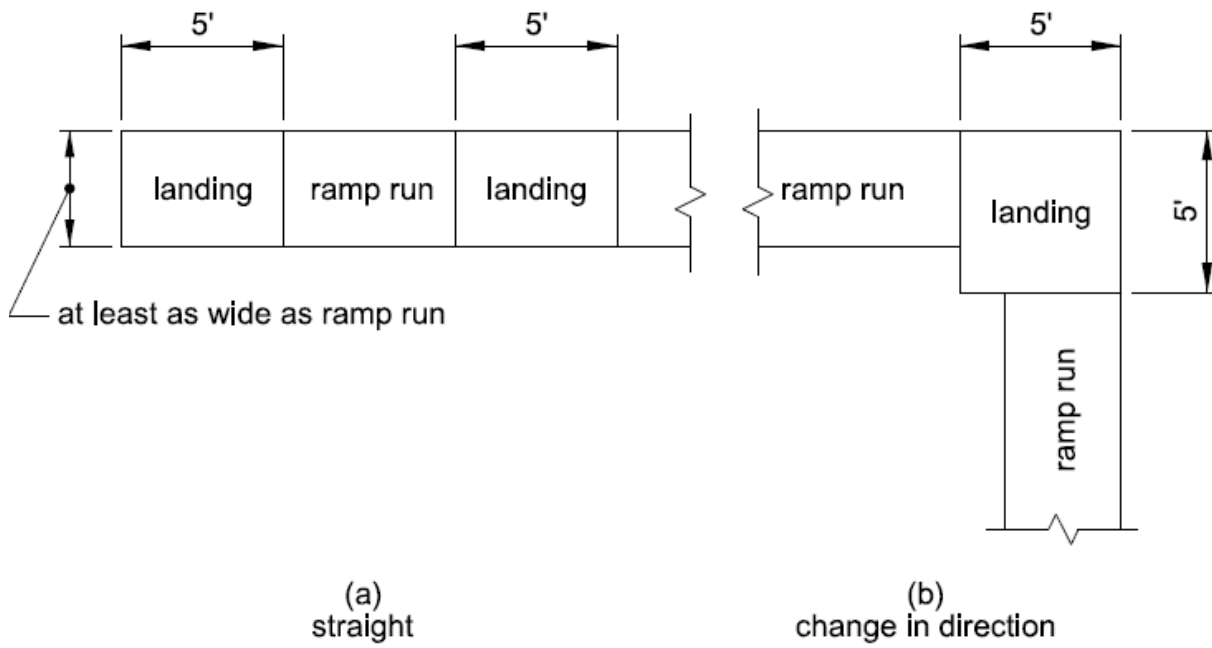

Figure 12-25 - Pedestrian Ramp Turning Space Requirements